



# CONTENTS | 目录

## 01 | OVERVIEW

PROFILE

MILESTONE

CULTURE

## 02 | LANDSCAPE

PHOTOVOLTAIC SOLAR

WEAR-RESISTANT MATERIALS

## 03 | HONORS

# 01

OVERVIEW



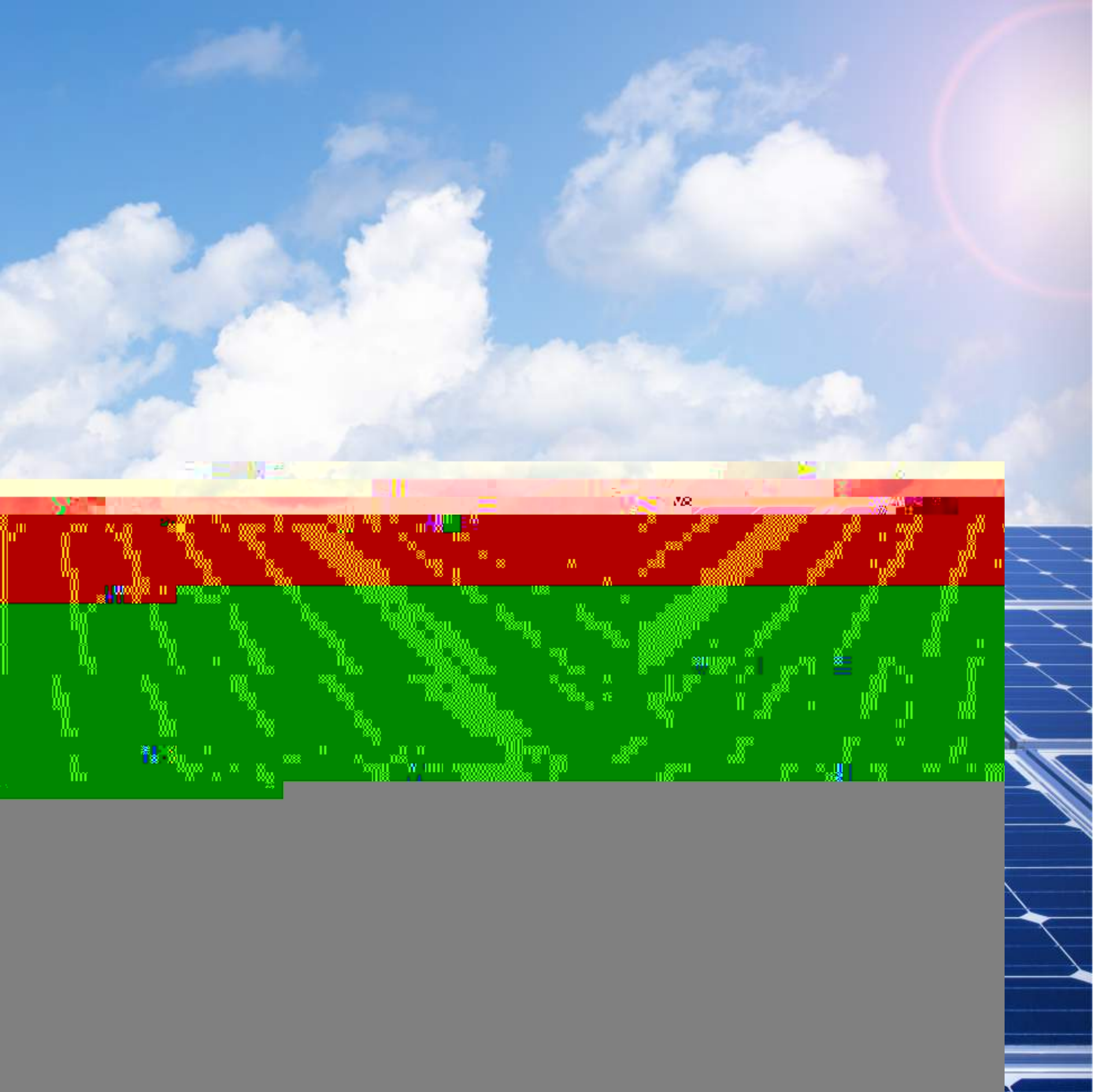

---

SZ300345) 1995 2012

---

(PIP )  
N HJT  
N

---

# DEVELOPMENT MILESTONES

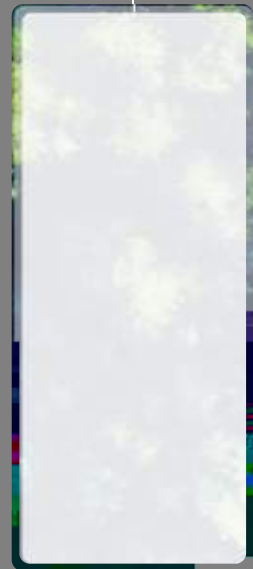
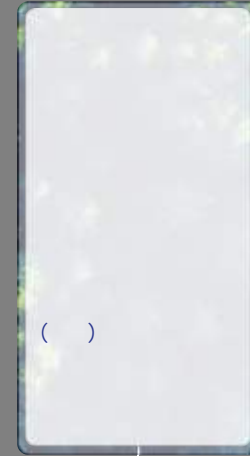
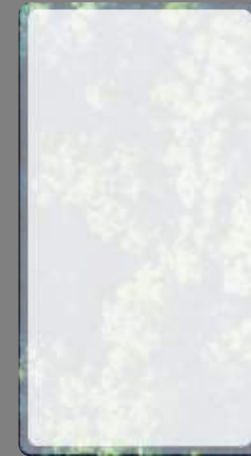
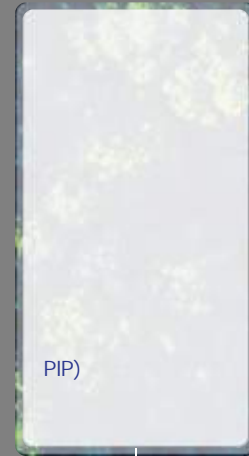
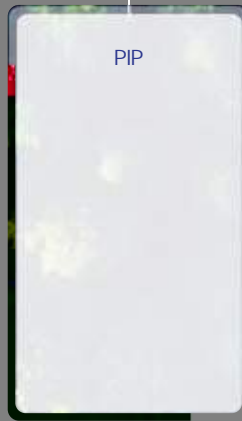
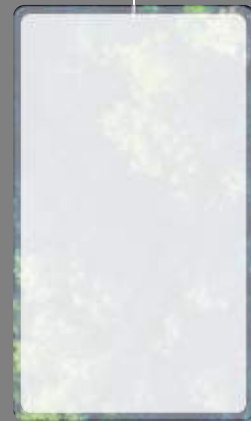
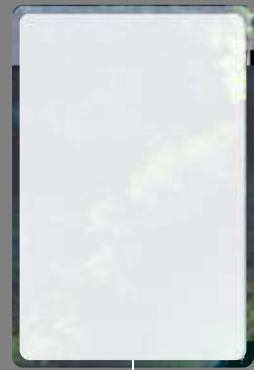

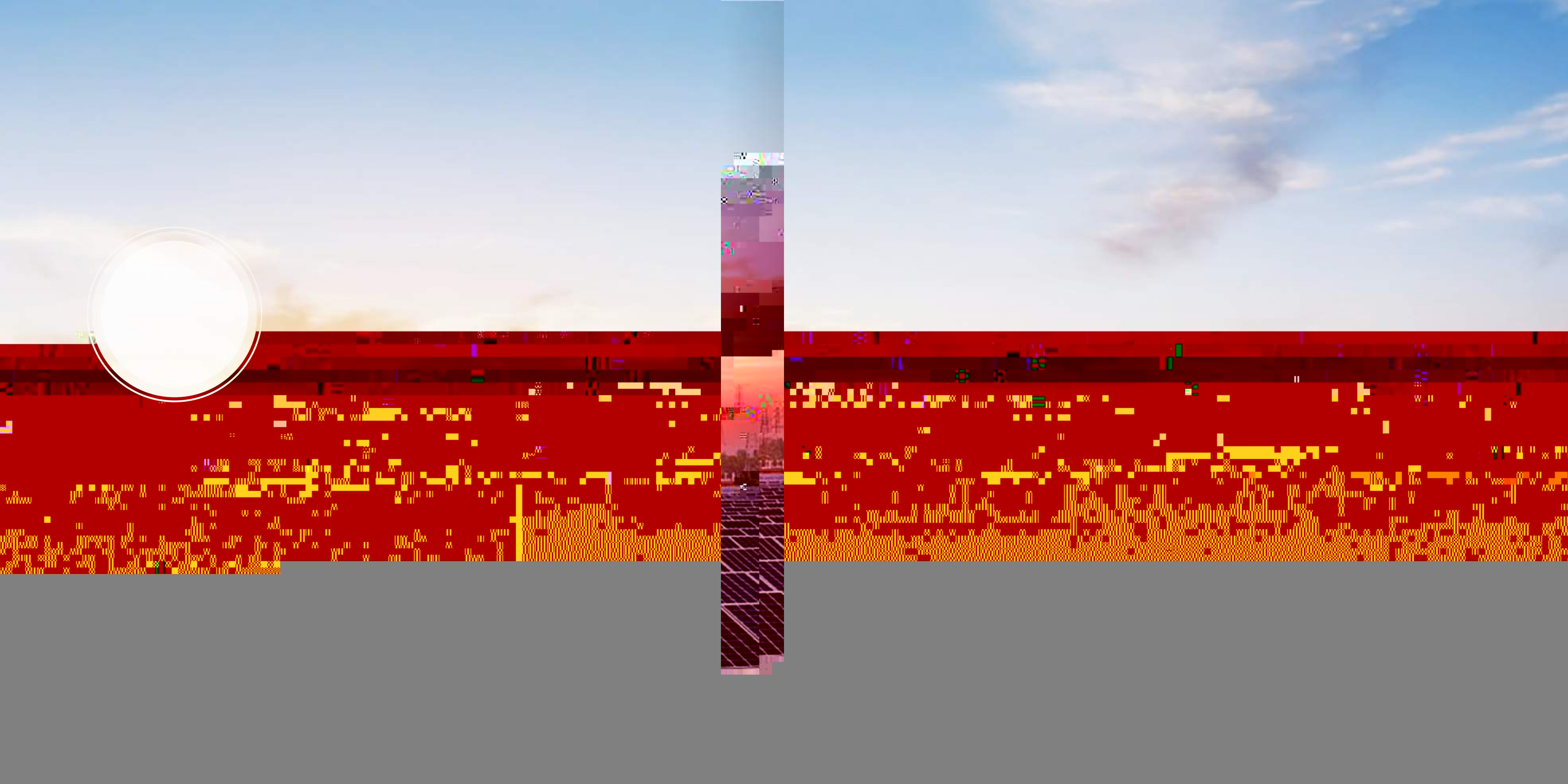

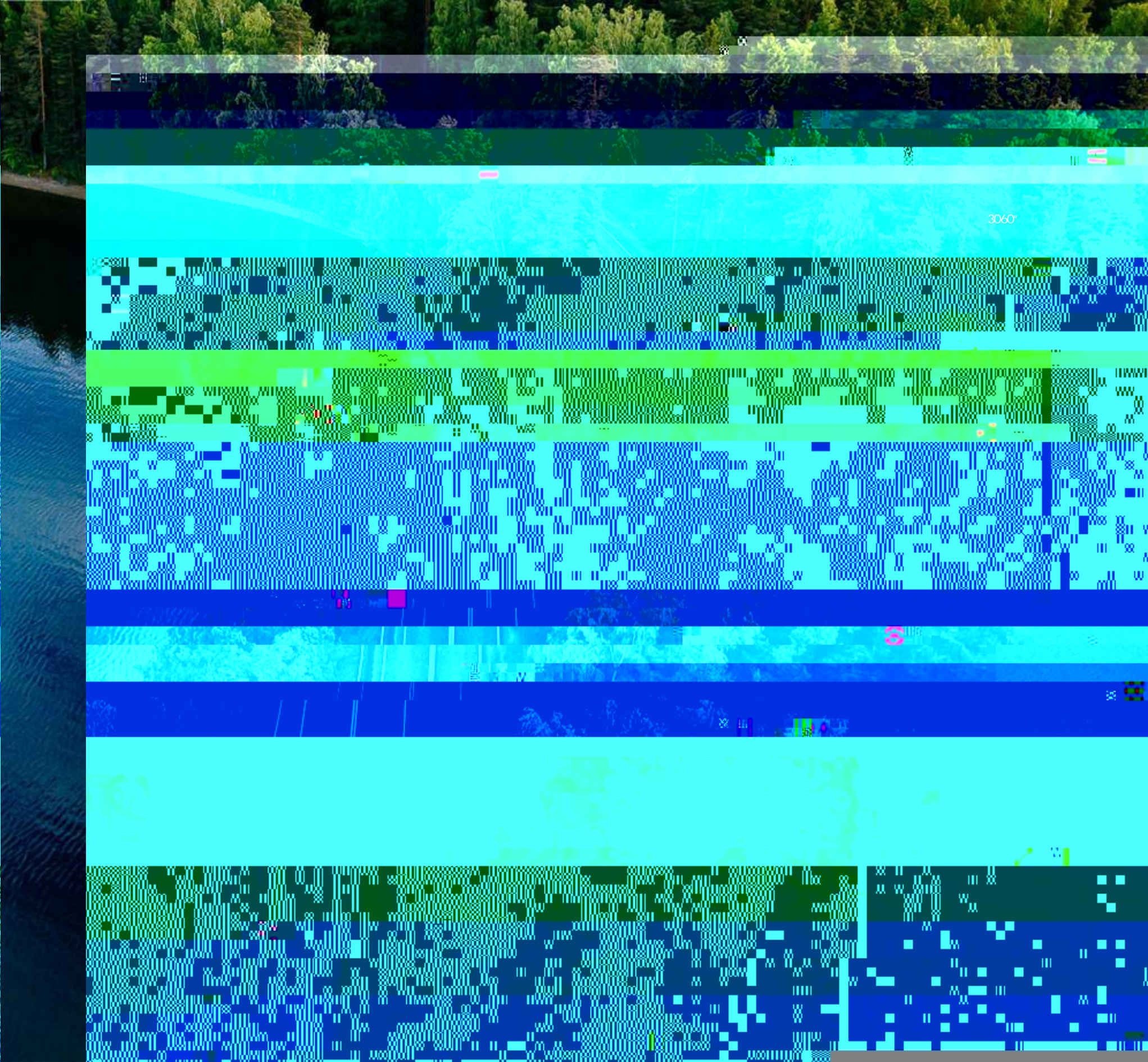
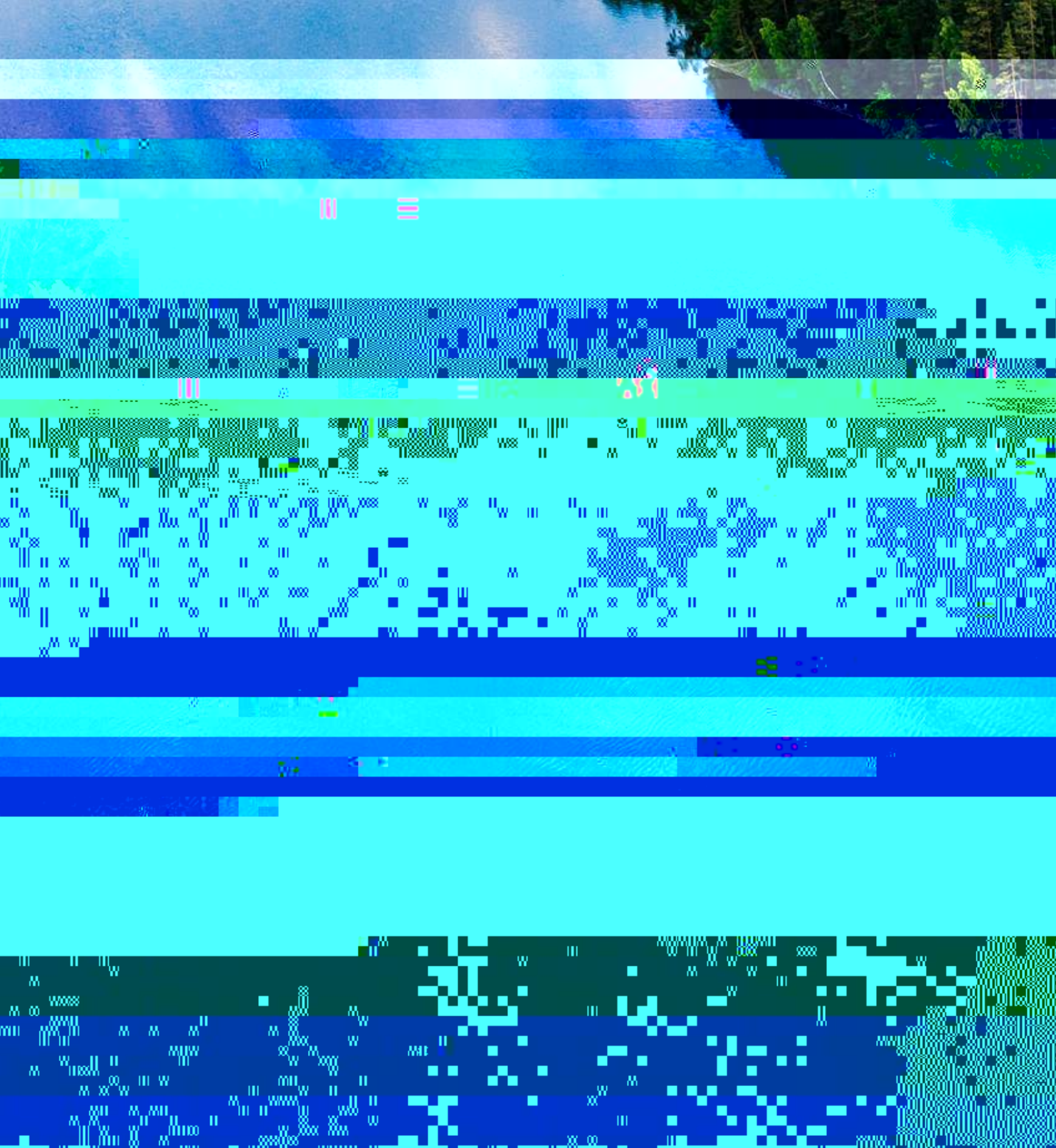



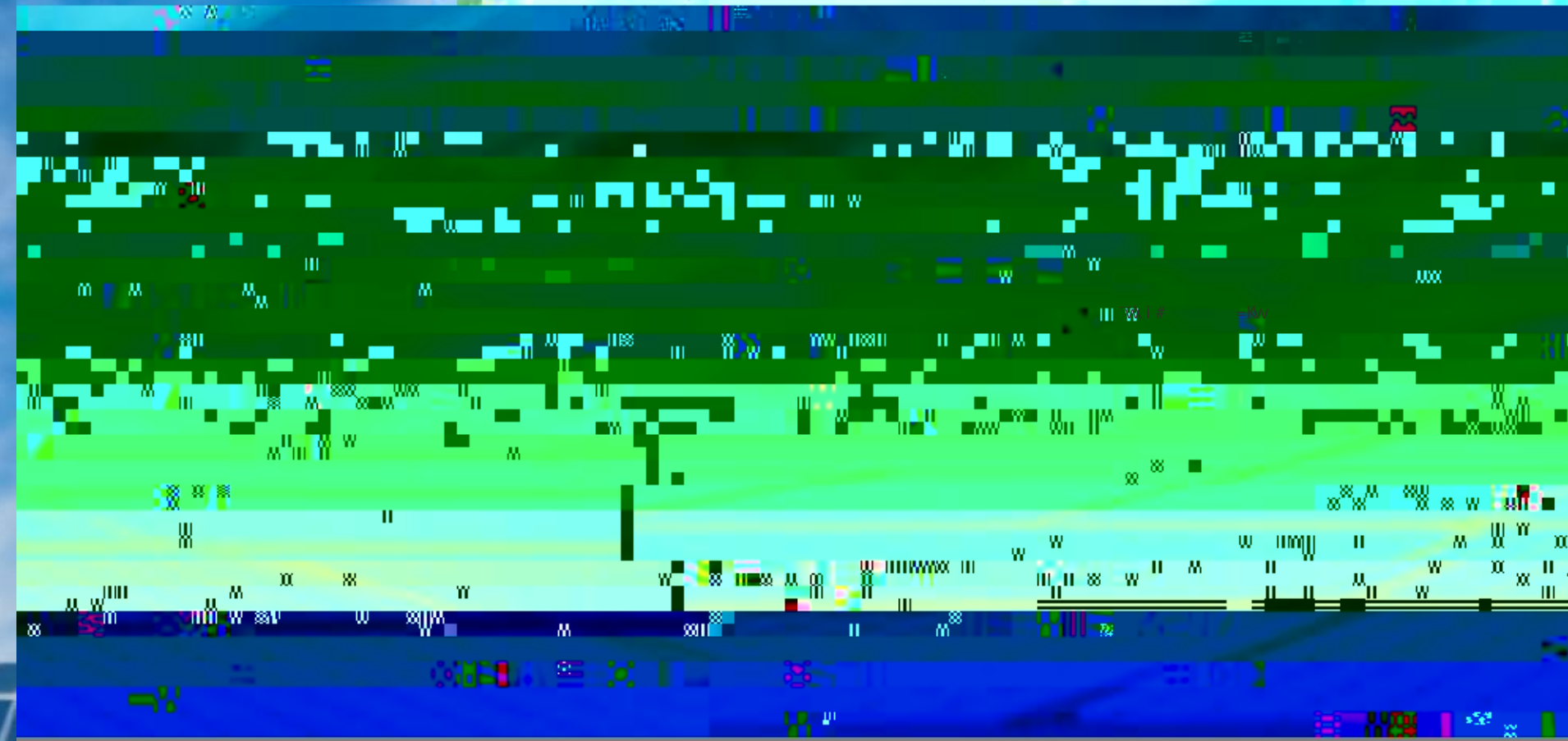

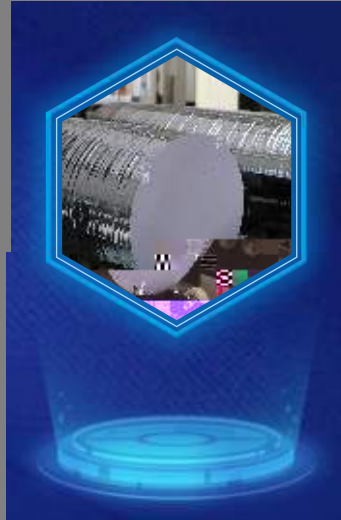

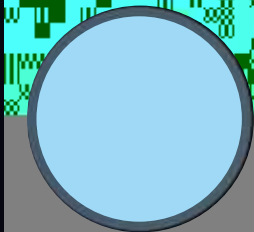
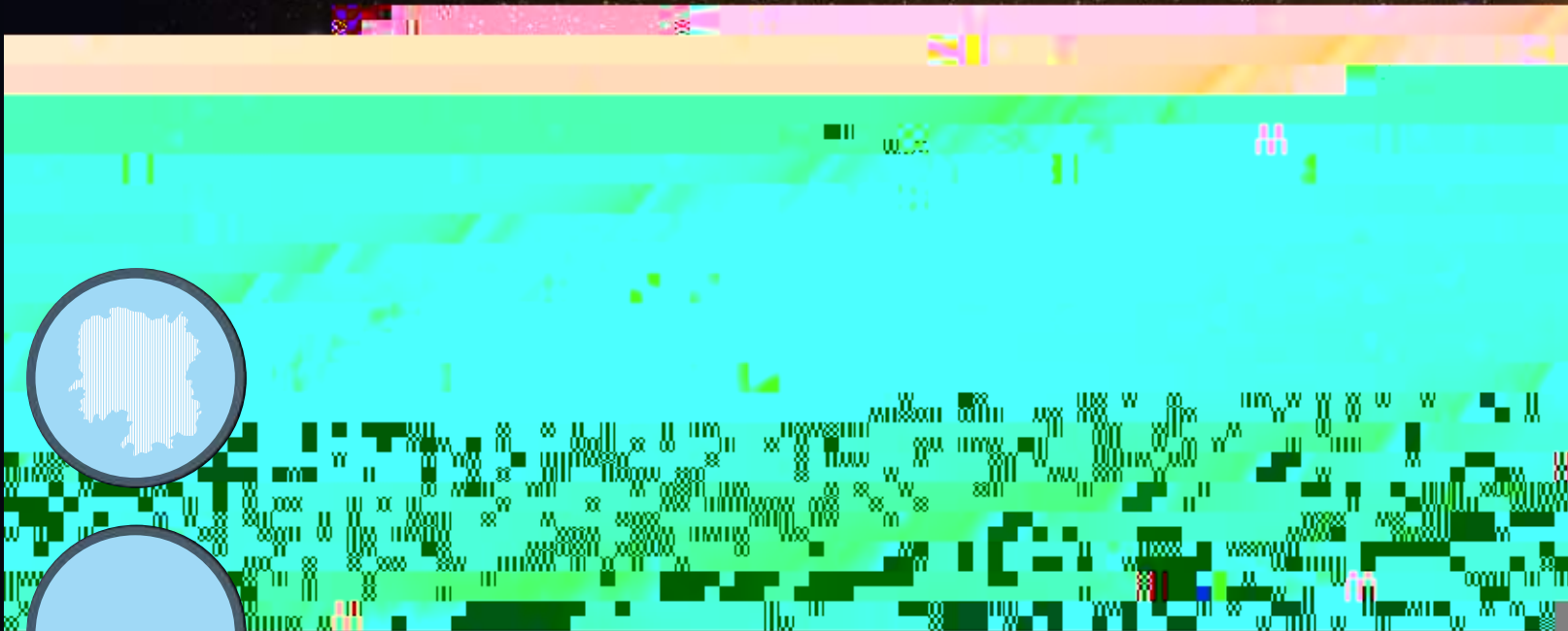





950mm

6500mm

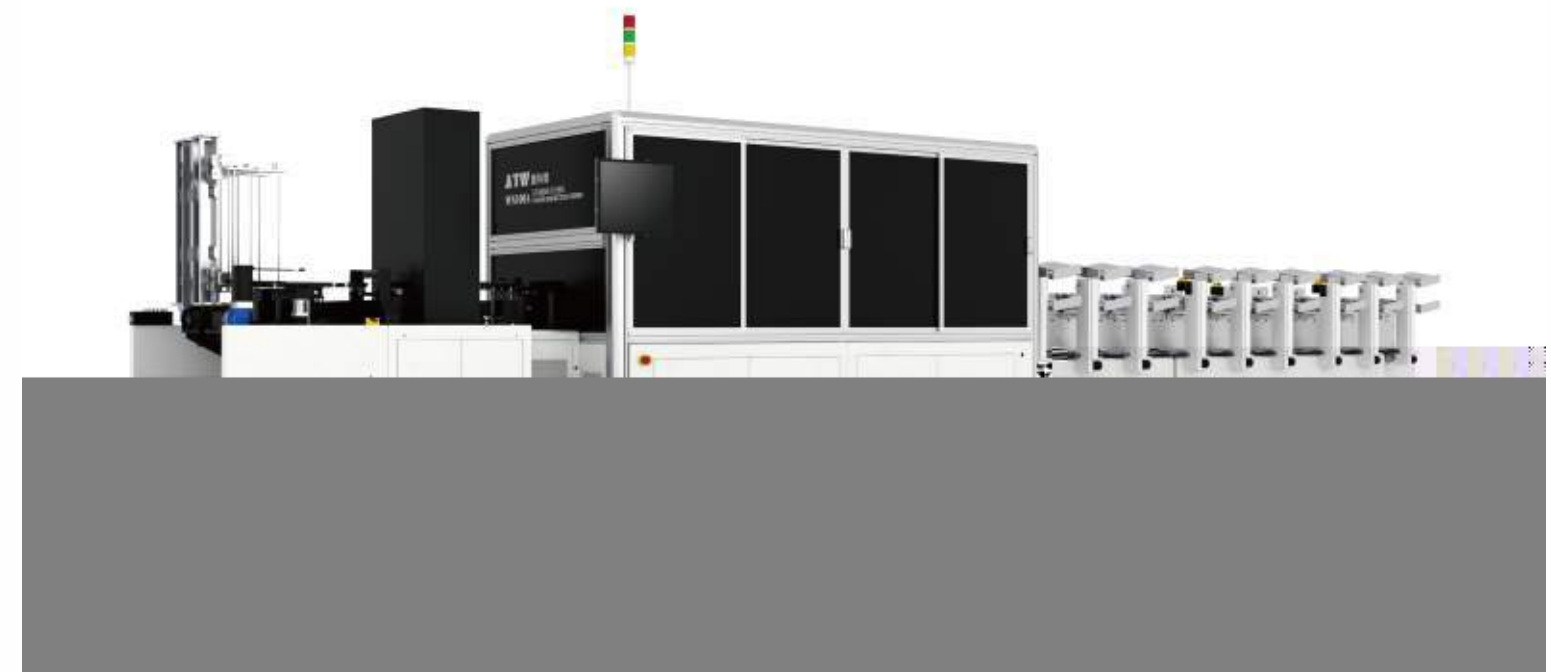

900mm  
0.25mm



1600



3

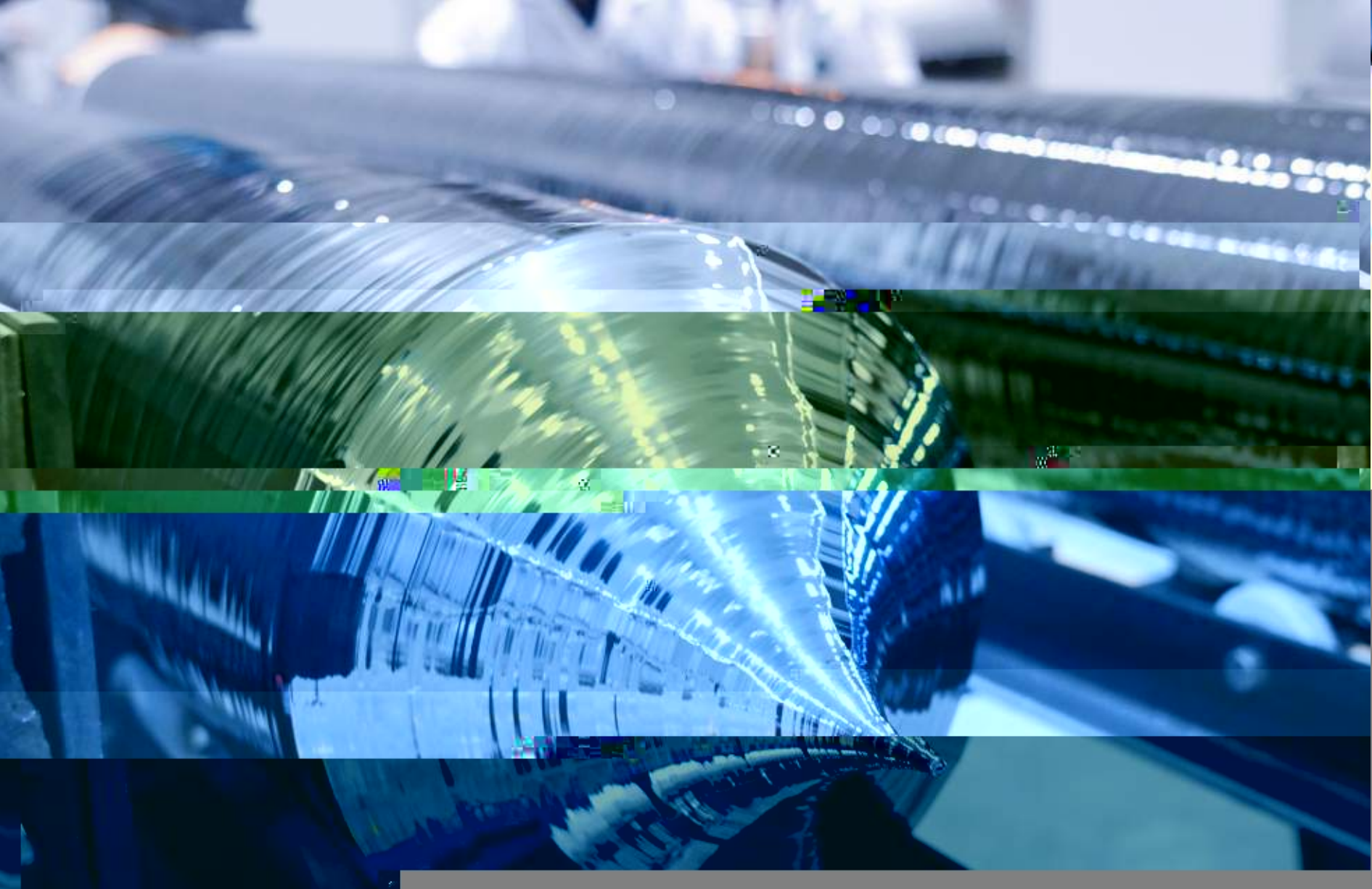

---

N



v



---

P



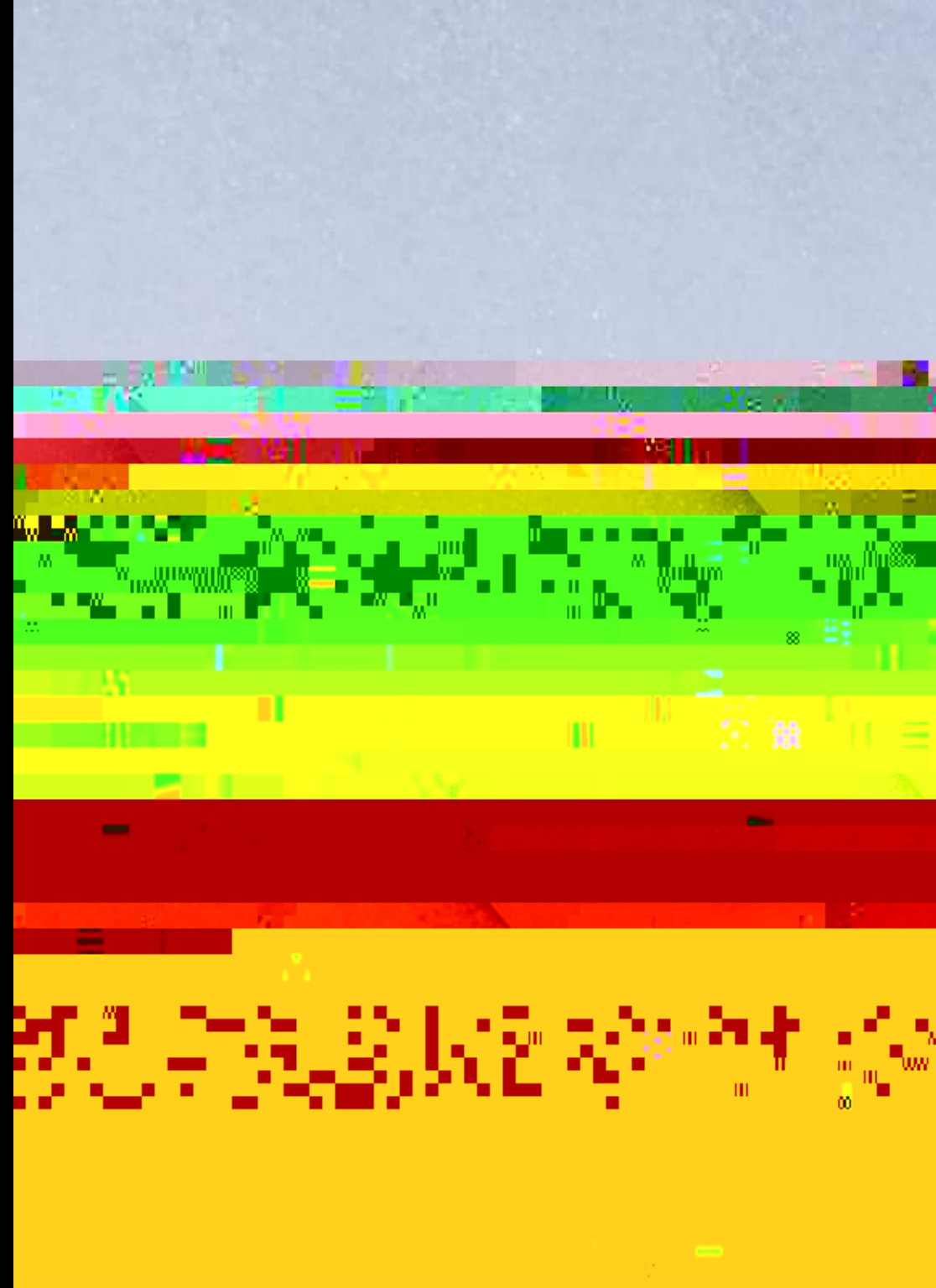
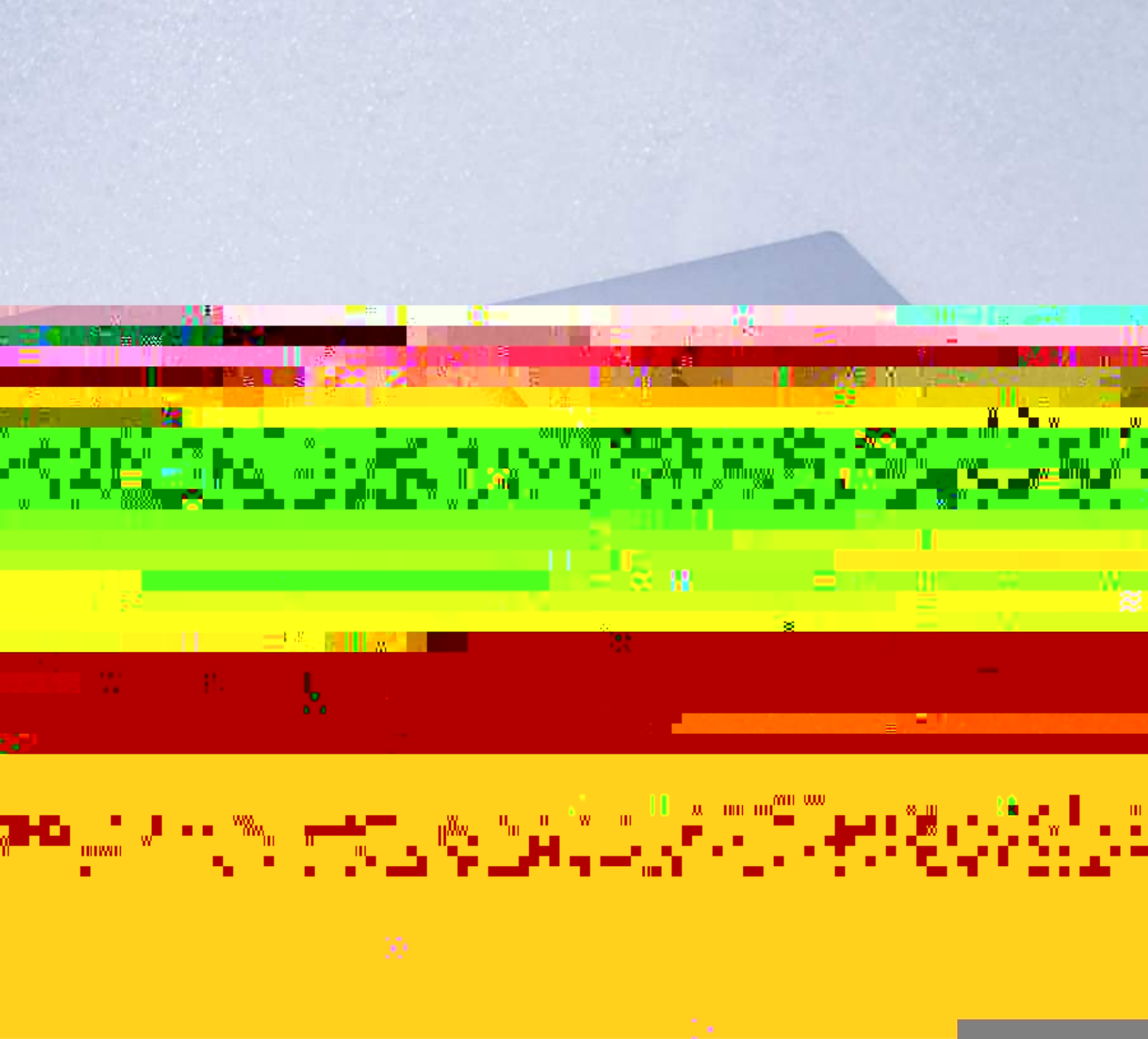

675W  
12BB(210mm)

HS-M10/108H  
HS-M10/120H  
HS-M10/144H  
HS-M12/120H  
HS-M12/132H

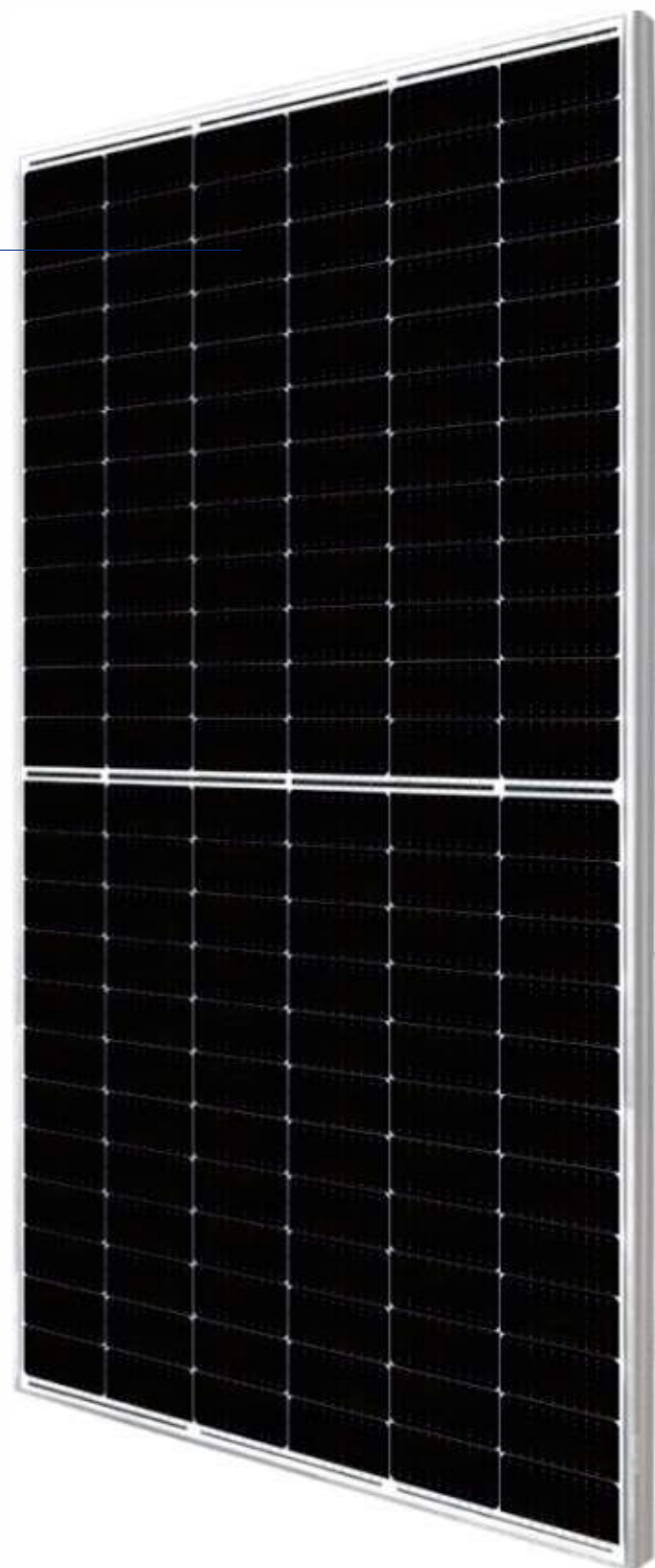

675W  
12BB(210mm)

HS-M10/108G  
HS-M10/120G  
HS-M10/144G  
HS-M12/120G  
HS-M12/132G





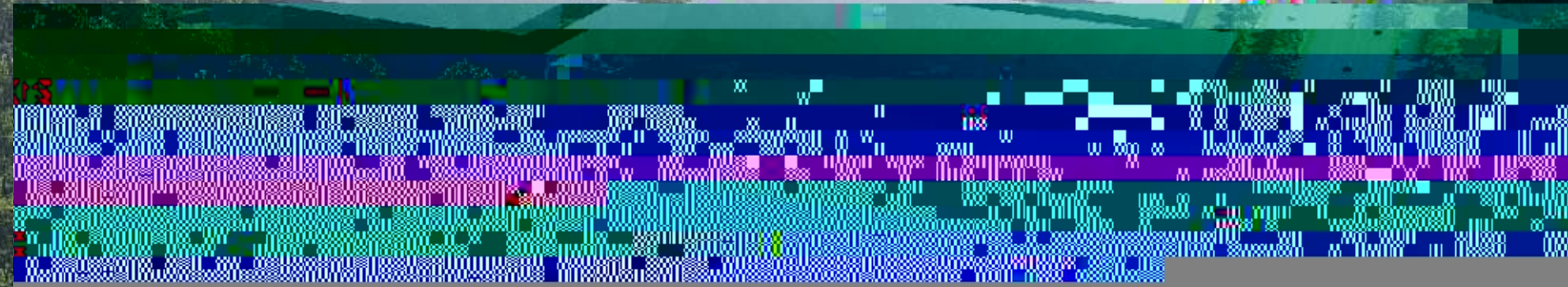
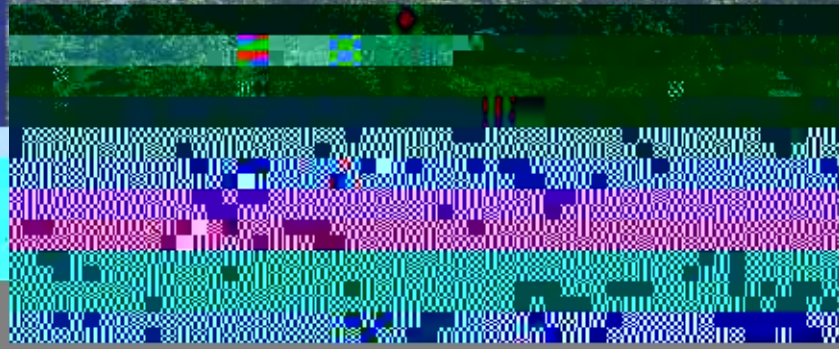
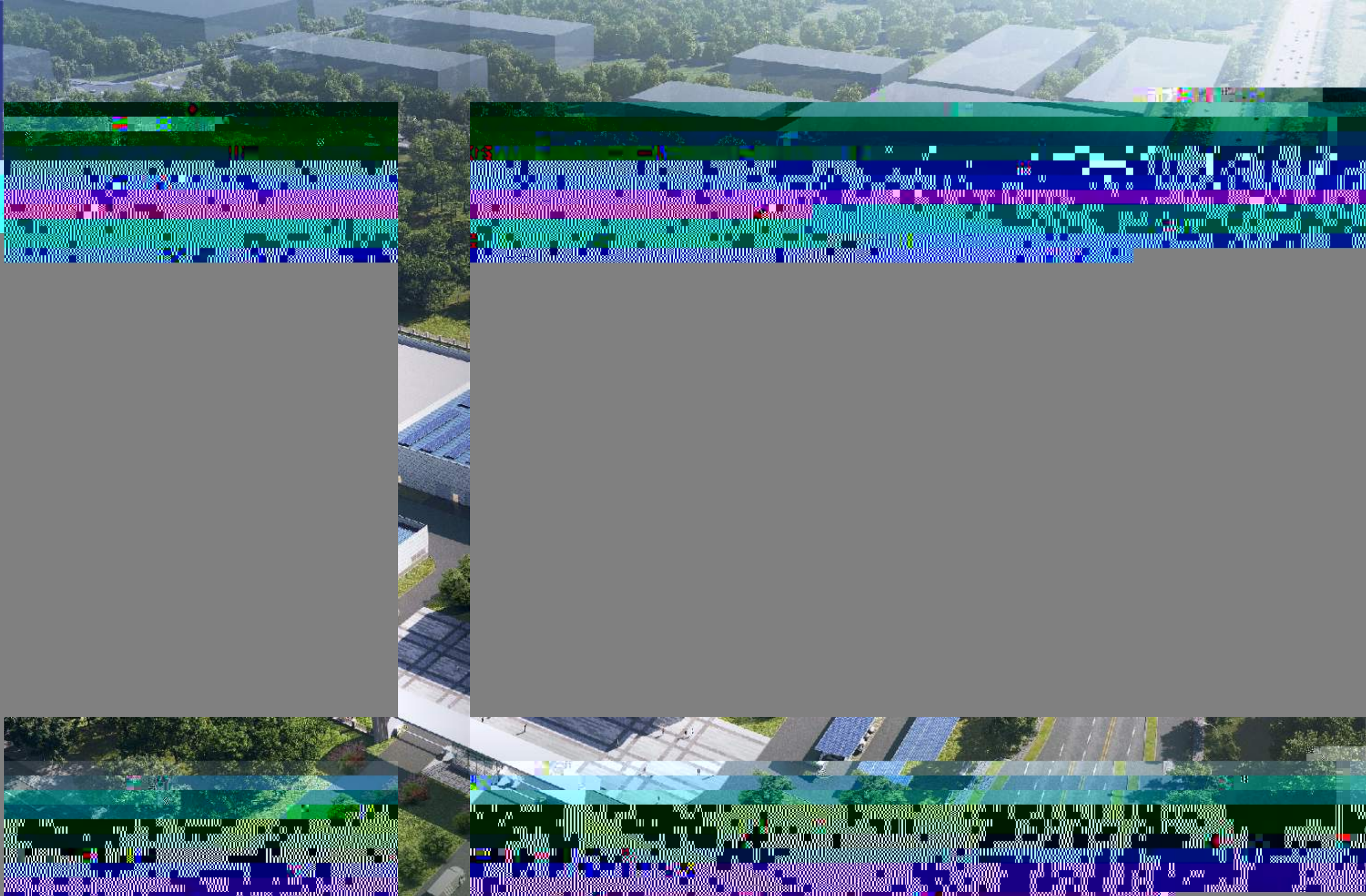
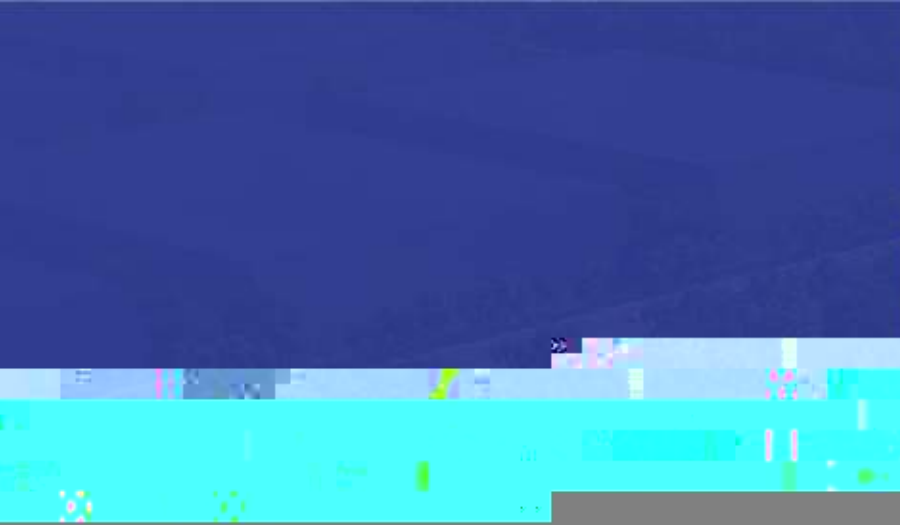

2023





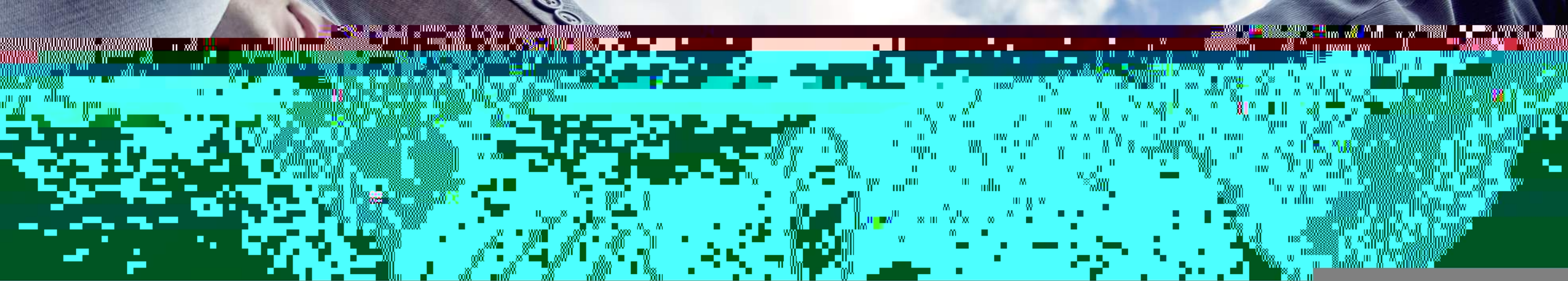



PIP

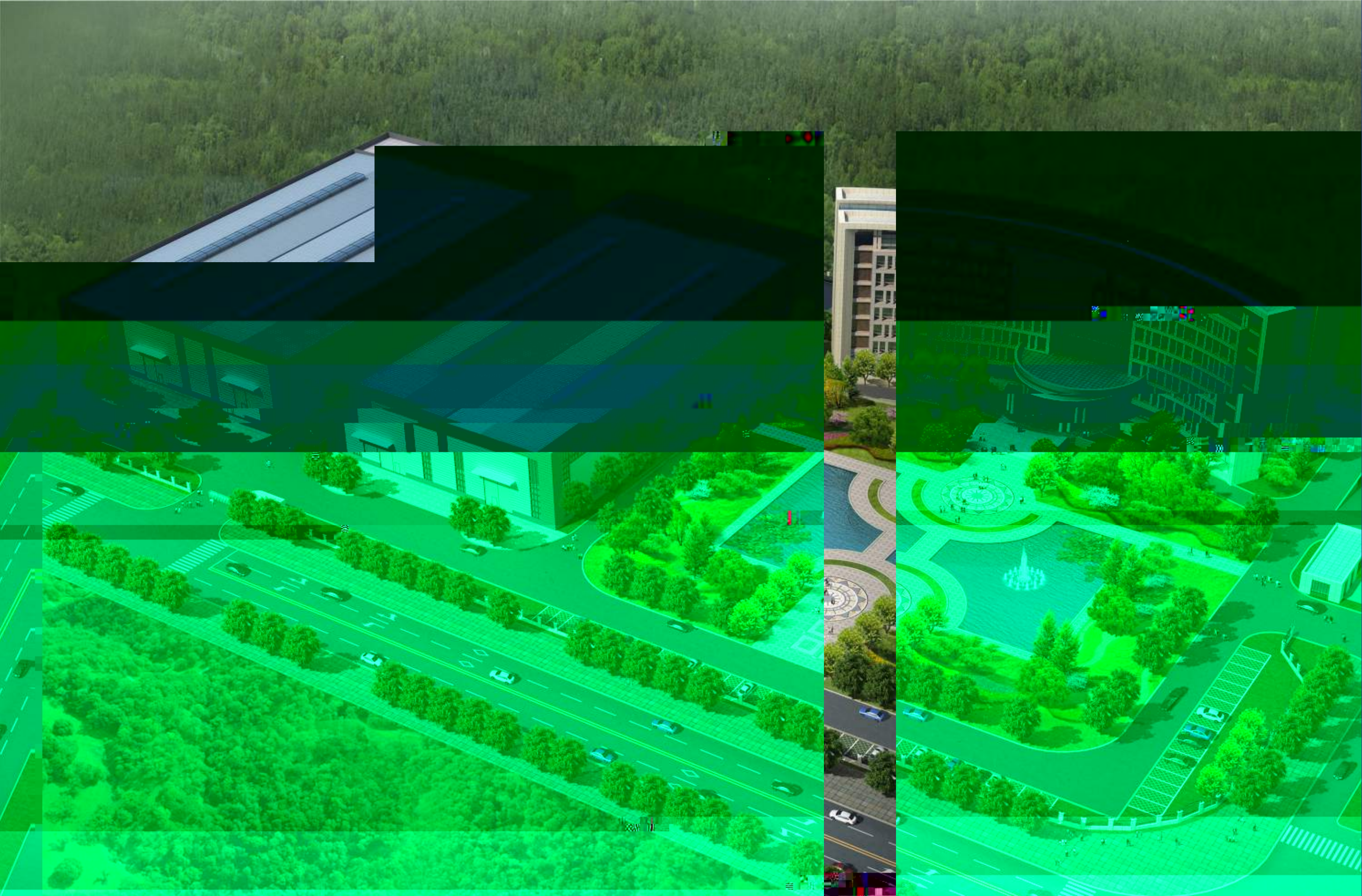

—



2017

ESCO Danielli Metso

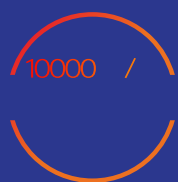
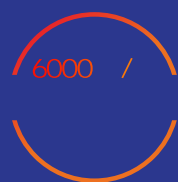

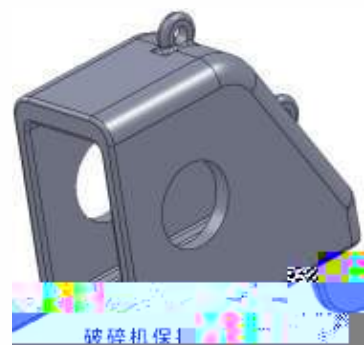
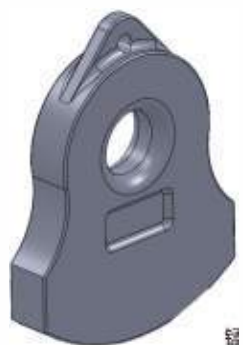

破碎机保



破碎机

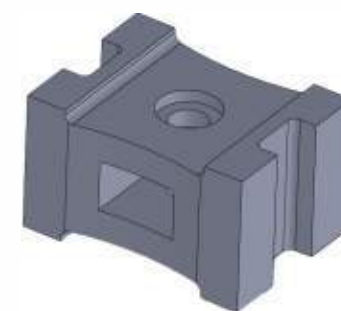
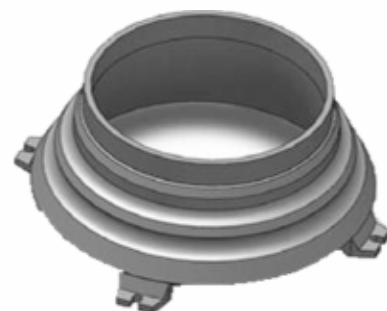
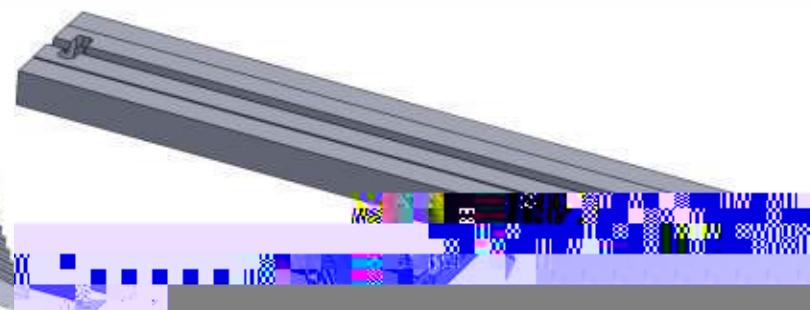
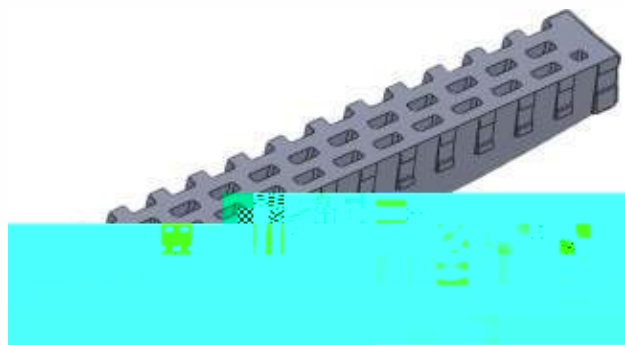

ISO9001  
100%



1.5-2

V、Ti



—

2015

PIP

PIP)



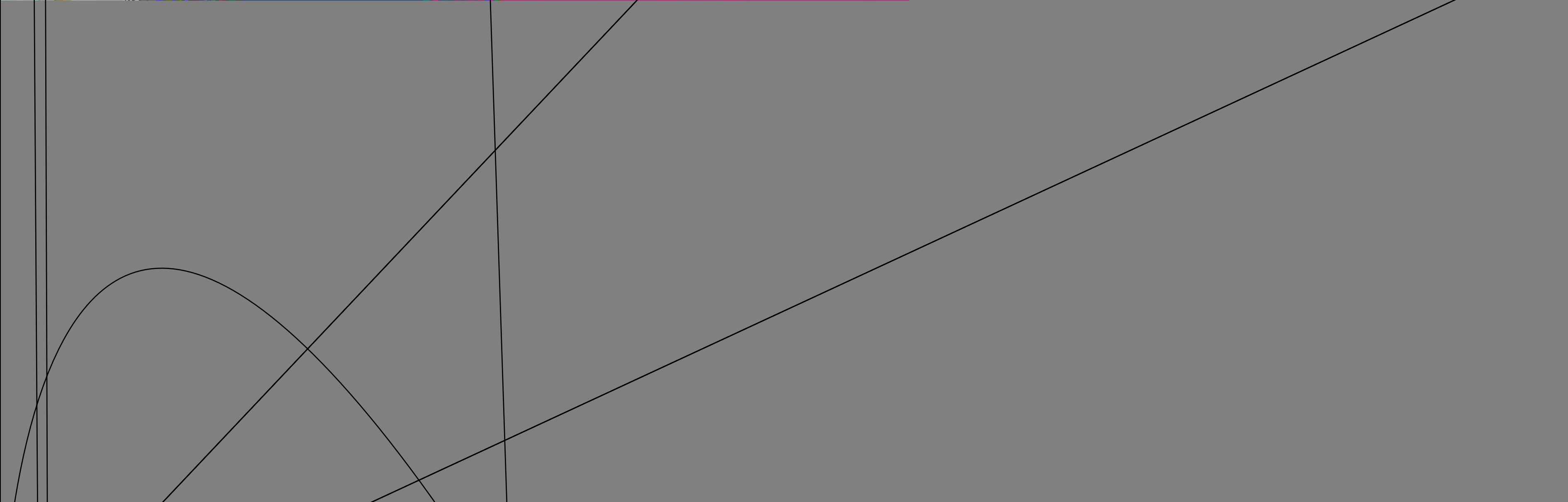
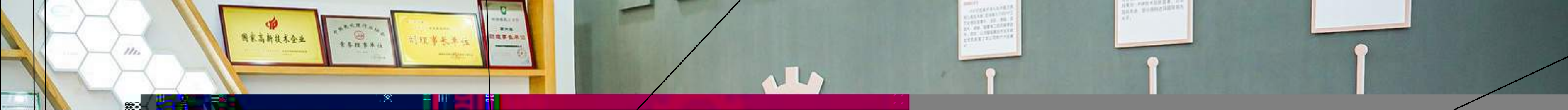



中国航天



中船重工



星邦重工 SINOBOOM



鞍钢集团



山西焦煤 SHANXI COKING COAL



长安工业 CHANGAN INDUSTRY



凯卓立



国家能源集团 CHN ENERGY



华润水泥 CR CEMENT



中国石化 SINOPEC



华新水泥 HUAXIN CEMENT



CETC



TISCO



CHINALCO



中国航发南方工业有限公司 AVIC SOUTH INDUSTRY CO., LTD.



中联重科

ZOOMLION 中联重科



LIUGONG



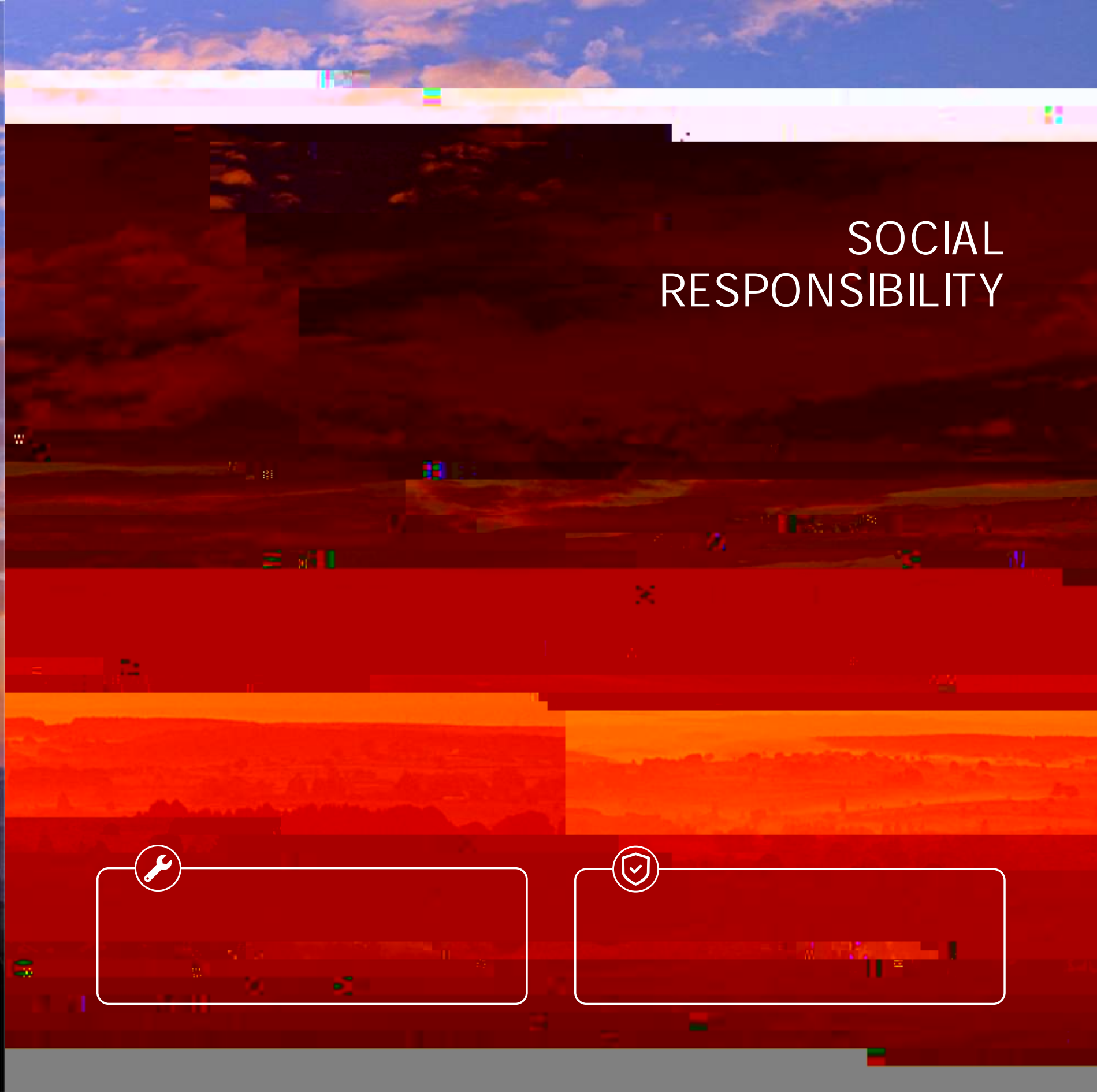
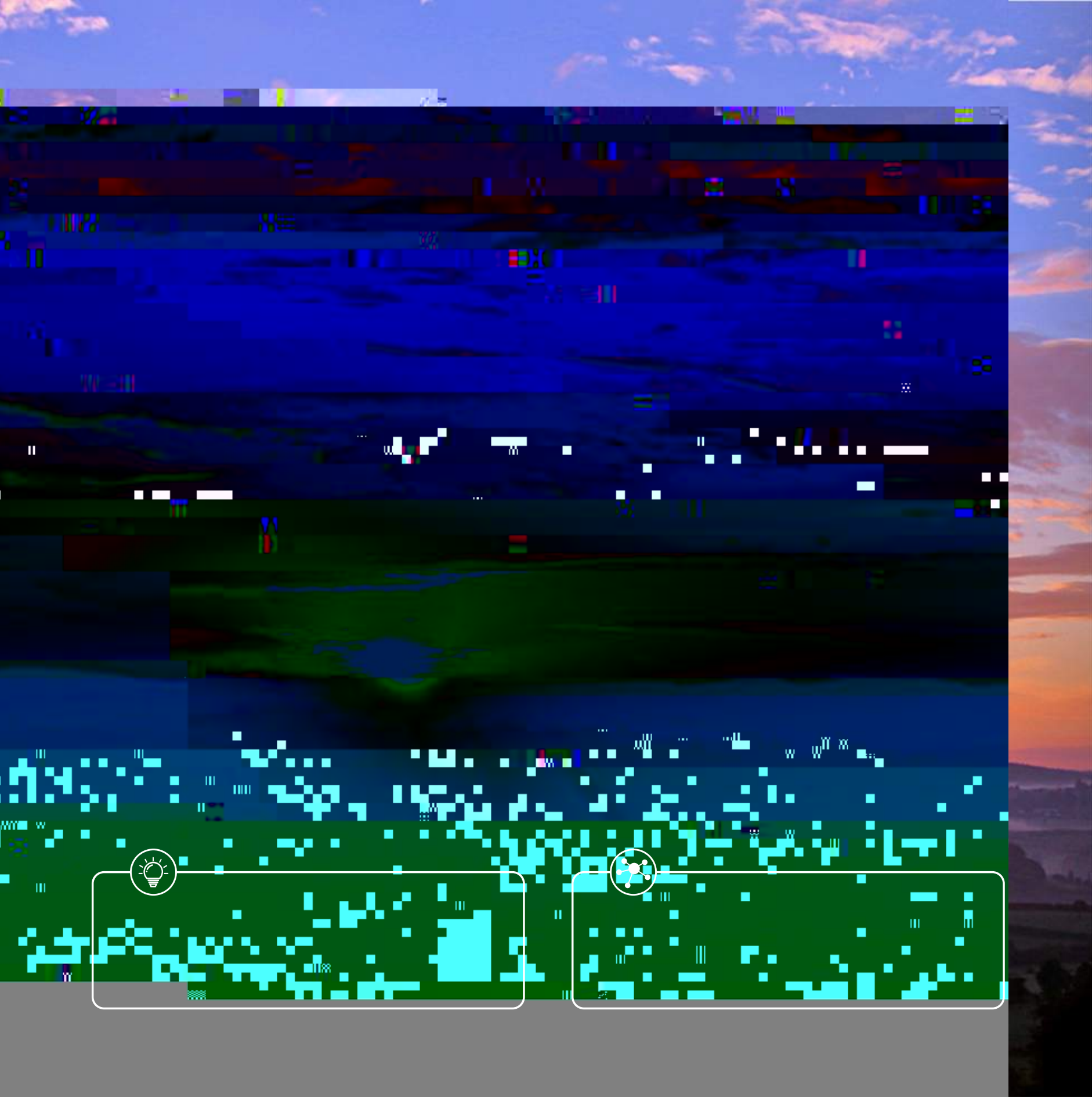

SOCIAL  
RESPONSIBILITY



